

PureCIP™

CLEANING IN PLACE (CIP) SYSTEM

The Biotech, Pharma and Critical
Application cGMP Validatable
Total Loss Cleaning In Place System



Overview

These skid mounted systems provide a robust and repeatable method of cleaning process equipment with temperature controlled solutions and added chemicals.

Skids comprise all the necessary water storage tanks, heaters, pumps, valves, pipework and related components and instrumentation to deliver the required CIP cycle. Type, quantity and physical sizes of components are determined during the design phase of each project to suit the required application.

System construction and components are suitable for sanitary use in pharmaceutical, biotech and other hygienic applications.

Systems include a user-configurable recipe based control system to suit a wide range of applications and are pre-assembled and fully tested with operating utility supplies in our works to minimise risk and optimise installation and validation time on-site.

Systems comply with all applicable regulatory standards and are accompanied by a comprehensive suite of documentation covering all aspects of installation, operation and maintenance. Extended documentation packages can be supplied to meet specific validation needs.

Constructed to cGMP, a lifecycle approach is adopted (DQ, FDS, HDS, SDS, FAT, SAT, IQ & OQ), with validation being key to every stage of the development process, including Factory Acceptance Testing (FAT), SAT and Qualification. All functions of the equipment would be fully wet and dry tested and test results would be documented in the FAT protocol.

Applications

- ✓ Cleaning of Tanks
- ✓ Vessels Intermediate Bulk Containers (IBCs)
- ✓ Vats, Fermenters
- ✓ Mixers Processors
- ✓ Pipework Flexibles
- ✓ Transfer Line Valves
- ✓ Fluid Bed Dryers Mills
- ✓ Coaters Filters
- ✓ Pumps
- ✓ Dryers Tumblers
- ✓ Fillers
- ✓ and many more in Pharmaceutical, Biotech and other Critical process industries.

GMP Construction

- ✓ FDA approved components with no threads and triclamp connections
- ✓ ASME BPE 316L no dead legs, fully drainable, material & weld traceability
- ✓ Control and instrumentation to GAMP5
- ✓ Repeatable, validatable client configurable sequences
- ✓ Riboflavin proof of coverage

PureCIP™ DATASHEET

Version 3.12



Welcome

Since our foundation in 1961, Suncombe has pioneered the development of innovative solutions for Cleaning In Place, BioWaste decontamination, GMP Washers, GMP skids, Sanitary Tanks and Vessels. The business continues to be privately owned and managed day to day by Dave Adams and Steve Overton.

Supporting Dave and Steve is a close-knit, dedicated, highly motivated and long-standing team encompassing a wealth of technical experience and knowledge in all relevant disciplines, including design, manufacture, testing, installation, validation, documentation and after-sales support. All of our work is carried out across our own facilities north of London near Stansted Airport.

The team employ the very latest techniques, standards and best in class solutions. Having such a strong team allows us to offer the ability to carry out all of our work in-house, under our direct control and quality management systems, ensuring that we own and preserve all the knowledge and experience gained with every project and offer continued support for all our installed systems throughout their lifetime.

Our policy is to re-invest much of our profits into continuous development of our staff and our facilities, together with Research and Development to provide the optimum technical solutions for our clients requirements.

Our Clientele



Our Equipment

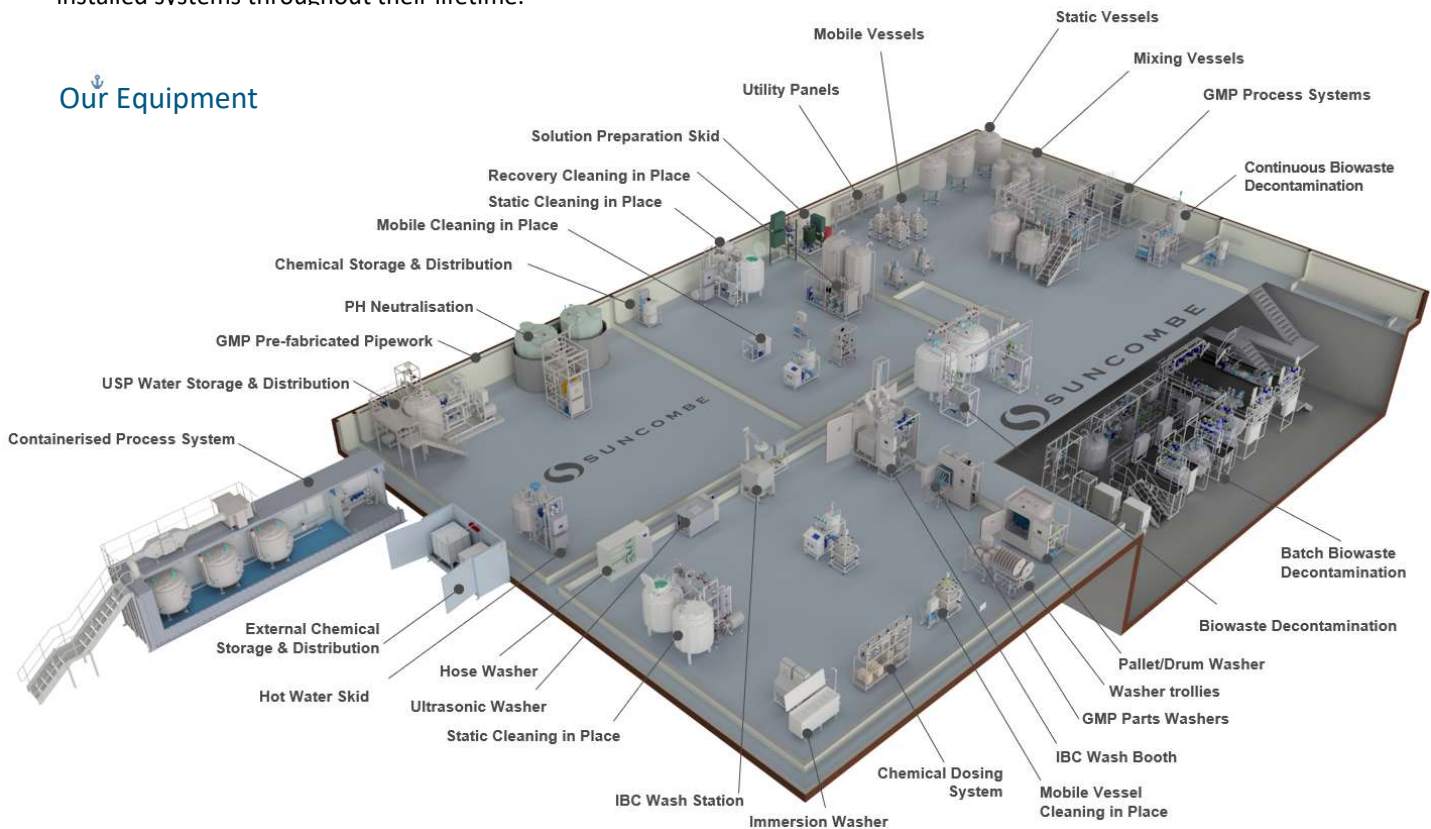

Suncombe Ltd

Suncombe House, Unit B Woodside Industrial Estate, Dunmow Road, Bishop's Stortford, CM23 5RG, United Kingdom
T +44(0)20-8443-3454 F +44(0)20-8443-3969
E info@suncombe.com W www.suncombe.com

PureCIP™ DATASHEET

Version 3.12

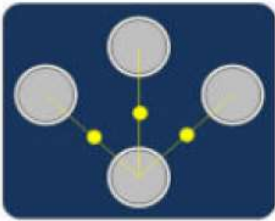

Key Features	Benefits
Sanitary 316L stainless steel construction and components	CIP fluids are maintained at the highest sanitary standards complying with ASME BPE offering guaranteed surface finishes with diaphragm valves, full material traceability, weld maps and tables and welding dossier.
Variable Duty Delivery Pump	316L Stainless Steel Heavy Duty Sanitary Delivery Pump with Variable Speed Drive to allow speed control to vary the delivery flowrate and pressure from the recipe, complete with PID loop and automatic impellor casing drain valve
Siemens PLC and 12" colour HMI with options for additional HMIs	Control hardware is industry standard and supported worldwide by Siemens. Ethernet interface included for transfer of critical operating variables to other systems. Designed to enable integration to third party equipment or higher level control system. Versions also available with remote I/O for control by clients control system.
Suncombe SmartCIP™ software	Control software specification has been developed and proven over many years for CIP applications and includes a wide range of user or administrator configurable parameters to enable customised cleaning recipes, including water flow, pressure, time, temperature, chemical concentration and many more. User passwords, Active Directory, Audit Trails, Electronic CIP batch reports for local or network storage are possible. User interface screens and process visualisation is simple, intuitive, clear and comprehensive. Remote access options are possible if required. Software complies with FDA 21CFR and EU GMP regulations.
CIP Vessel/s	316L Stainless Steel Pressure vessel with heated 0.2µm Vent Filter, bursting disc, sanitary construction with riboflavin tests. Water storage or chemical make-up vessels.
Single-pass or Recirculation options	CIP fluids can be immediately discarded to waste after use ("Single Pass") or may be recirculated to reduce overall water and energy consumption.
Steam, hot water/oil or electric water heating options	Heating energy may be derived from most convenient and cost-effective source available.
Heated Solution Preparation	Heated solutions can be batch made up in CIP vessel/s or using In-Line Heating validated method
USP Water	1, 2 or 3 water inlets for Soft Water, Purified Water and Water for Injection. Water can either fill vessel or bypass vessel for direct application.
Continuous monitoring of key parameters	CIP process is highly repeatable and validatable.
Variable chemical dosing	Delivery of 1, 2, 3 or 4 chemicals into CIP fluids is controlled.
In-line or batch chemical dosing	Chemical solutions can be batch made up in CIP vessel/s or using optional In-Line Dilution validated method with flowmeter. Option for conductivity concentration verification.
Scavenge/Return	Skid prepared to accept return of fluids from optional scavenge pump/s, gravity drains or other site method of equipment liquid return
Plug 'n' Play	Fully integrated with comprehensive in-house testing to ensure fast start up on site
CIP Distribution	A single CIP outlet is included. Options available for up to 10 separate CIP outlets for feeding to different items to be CIP'ed. Each outlet can be a single or double valve for CIP isolation. Distribution can also be via flowplate/splitter panel.
	
	Typical flowplate/splitter panel
CIP Solution Cooling	Coolers can be added for colder CIP rinses or drain cooling.
Air Purge	Includes air purge facility to evacuate all water from the CIP pipework
Fully Drainable	Automatic valves to fully drain entire skid including pump casing
Instruments	Sanitary instruments of Endress and Hauser/Mettler Toledo or equivalent with full material and calibration certification.
Final Rinse Confirmation	Final Rinse Conductivity to confirm completion of Cycle

PureCIP™ DATASHEET

Version 3.12

Diagram of Typical Configuration

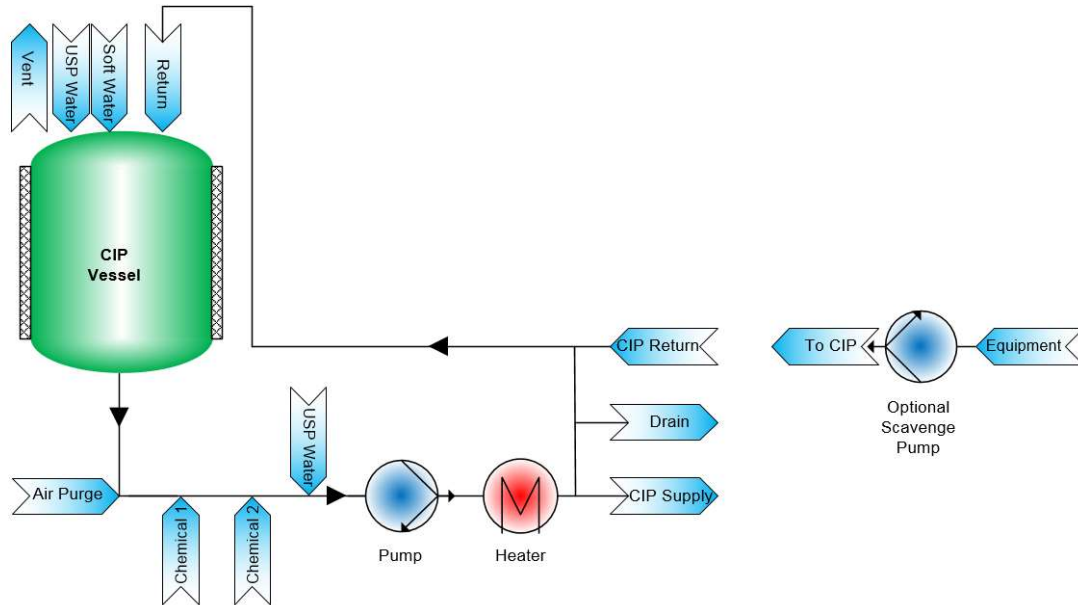

Layout Drawing

PureCIP™ 750 shown with 750 litre Vessels – up to 3000 litre capacity vessels available.

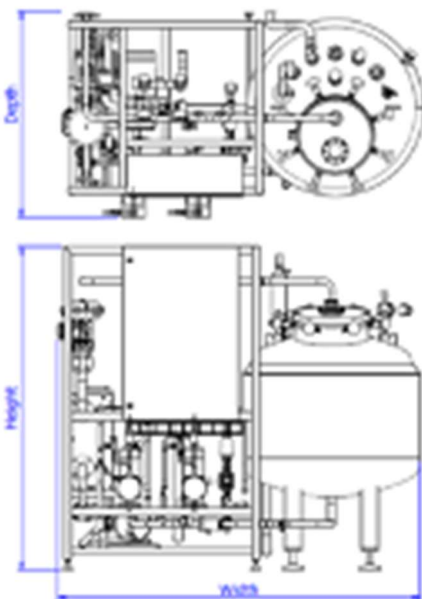

Dimensions

These are typical only and should be confirmed.

Part #	Vessel Capacity litres	Flowrate litres per minute	Width mm	Depth mm	Height mm
PureCIP™ 150	150	0–60	1,600	840	1,850
PureCIP™ 300	300	0–80	2,000	1,000	2,000
PureCIP™ 500	500	0–120	2,200	1,200	2,300
PureCIP™ 600	600	0–150	2,300	1,300	2,500
PureCIP™ 750	750	0–300	2,500	1,400	2,500
PureCIP™ 1000	1000	0–300	2,500	1,400	2,800
PureCIP™ 1500	1500	0–300	2,500	1,400	3,100
PureCIP™ 2000	2000	0–300	2,500	1,400	3,400
PureCIP™ 2500	2500	0–300	3,000	2,000	3,000
PureCIP™ 3000	3000	0–300	3,000	2,000	3,400

All Systems also available with 0, 2, 3, 4 or more vessels.
 All Systems also available with Shell and Tube Heat Exchanger with depth increase of 400mm.

PureCIP™ DATASHEET

Version 3.12

Diagram of Typical Configuration

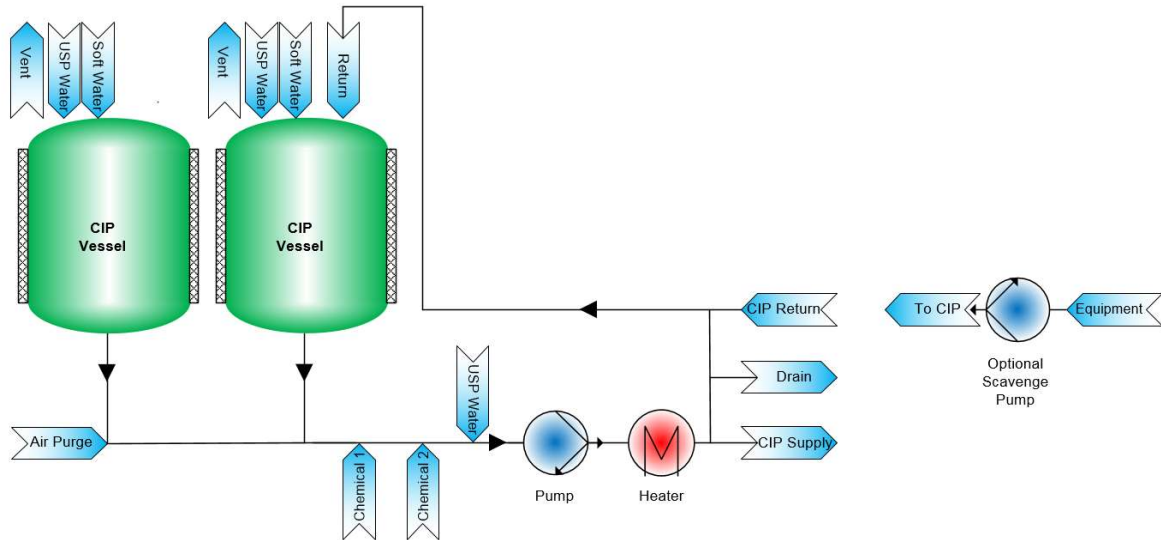

Layout Drawing

PureCIP™ 750 shown with 2 x 750 litre Vessels – up to 3000 litre capacity vessels available.

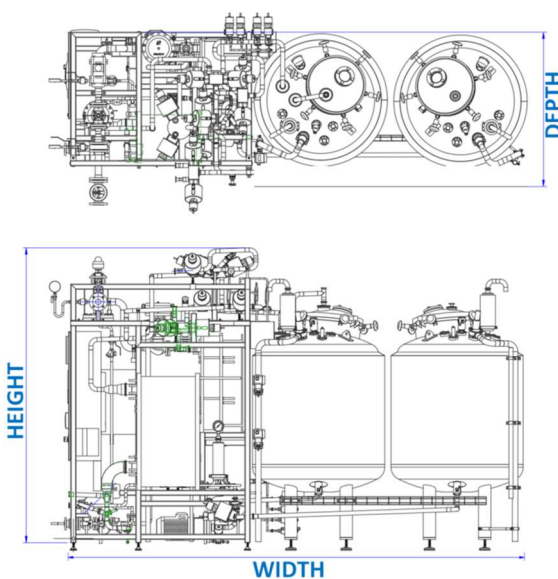

Dimensions

These are typical only and should be confirmed.

Part #	Vessel Capacity litres	Flowrate litres per minute	Width mm	Depth mm	Height mm
PureCIP™ 150/2	150	0–60	2,300	840	1,850
PureCIP™ 300/2	300	0–80	2,500	1,000	2,000
PureCIP™ 500/2	500	0–120	2,700	1,200	2,300
PureCIP™ 600/2	600	0–150	2,900	1,300	2,500
PureCIP™ 750/2	750	0–300	2,900	1,400	2,500
PureCIP™ 1000/2	1000	0–300	3,000	1,400	2,800
PureCIP™ 1500/2	1500	0–300	3,200	1,400	3,100
PureCIP™ 2000/2	2000	0–300	3,400	1,400	3,400
PureCIP™ 2500/2	2500	0–300	4,200	2,000	3,000
PureCIP™ 3000/2	3000	0–300	4,500	2,000	3,400

All Systems also available with 0, 1, 3, 4 or more vessels.
All Systems also available with Shell and Tube Heat Exchanger with depth increase of 400mm.

Typical PureCIP™



Typical Mobile PureCIP™ (MobileCIP™)



Typical PureCIP™ Operator Interface HMI

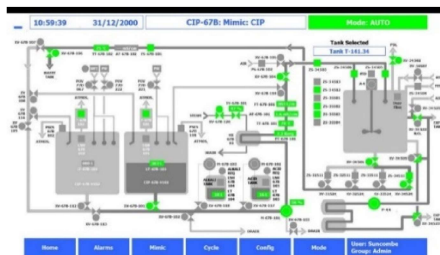

Typical PureCIP™ Operator Interface HMI Recipe Configuration

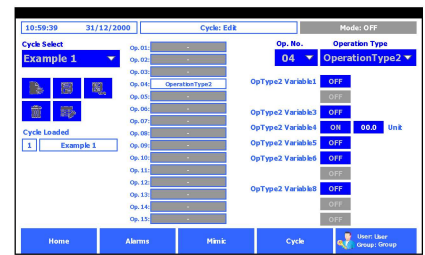
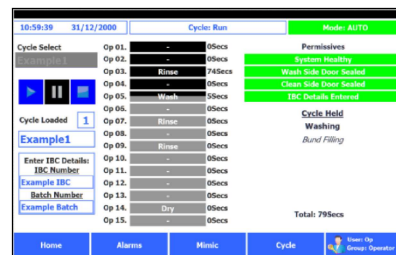

Utilities

Water (Soft, USP, PW, WFI - 1, 2 or 3 waters)	20 - 300 litres/min @ 1 bar (dependant on tank usage)
Compressed Air (internal regulator)	Minimal use @ 7bar
Air Purge (internal regulator and HEPA filter)	700 Slpm
Electricity	>12 kW 400Vac 3ph+n 50hz. Other voltages available to order
Steam and Condense	To be confirmed dependant on system duty @ 3 bar for double plate heat exchanger
Drain	20 - 300 litres/min @ 1 bar (as per system flowrate)

PureCIP™ DATASHEET

Version 3.12

Diagram of Typical Configuration with three Tanks, two channels and multiple scavenge pumps

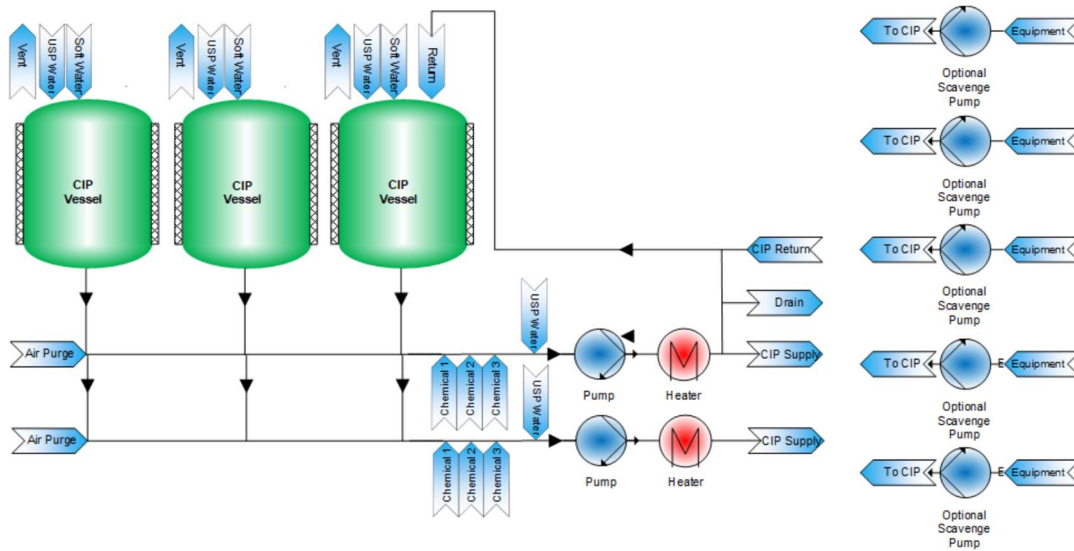

Diagram of Typical Configuration without a Tank

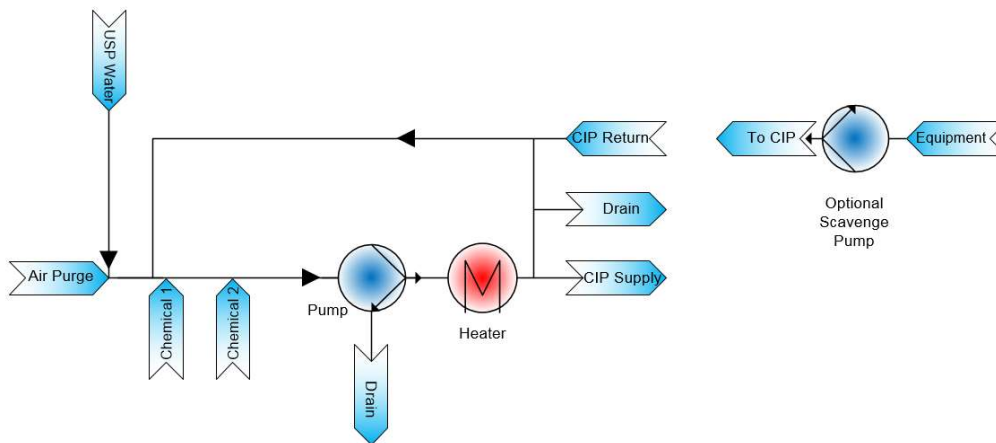
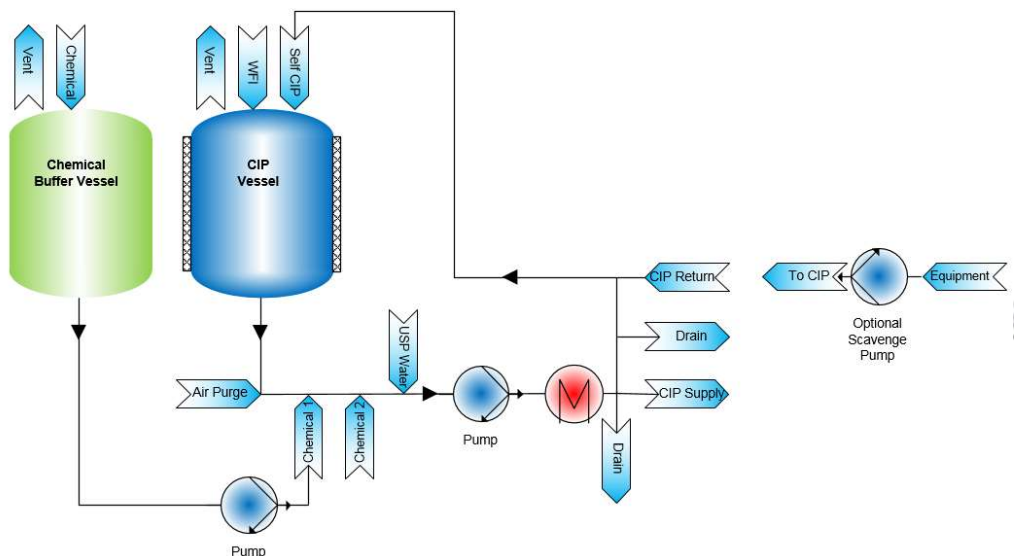

Diagram of Configuration with a Chemical Buffer



Control and Automation System

Renowned for their ease of operation and versatility, Suncombe systems are designed and manufactured for reliability, repeatability and longevity, whilst complying with the highest international regulatory standards. With dedicated in-house automation personnel for control design and software, Suncombe engineers have tremendous experience in incorporating a broad range of control solutions to suit your specific control requirements.

Developed to the GAMP 'V' model (Verification and Validation), system life cycle approach, which links the three main qualification activities (installation, operation and performance) back to the design process, the system software is produced in house by qualified software engineers, encompassing software development standards, quality control systems and change control during and post development.



Standards and Guidelines

- ✓ GAMP Guidelines
- ✓ FDA 21CFR11 Compliance
- ✓ ASME BPE
- ✓ EU Machinery Directive
- ✓ EU Low Voltage Directive
- ✓ EU cGMP Guidelines
- ✓ EU EMC Electromagnetic Compatibility Directive
- ✓ IEC 61131 for PLCs
- ✓ EN 60204 Safety of machinery
- ✓ EN 60439 Low Voltage Switchgear
- ✓ CE and UKCA Marks

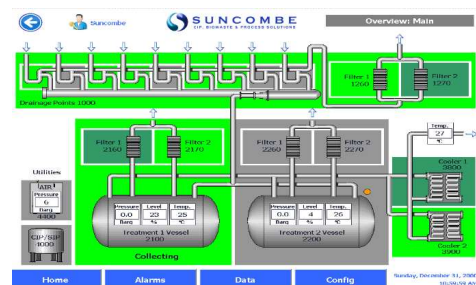

Typical Operator Interface



